

Break down protocol barriers and make industrial digitization more convenient and efficient

IG902 Series High performance Edge Computer



- Multiple means of Internet access
- Rich interfaces
- Built-in DSA
- Cloud Management

InGateway902 is InHand Networks' high-performance edge gateway designed specifically for the industrial Internet of Things (IIoT) sector. With its compact size, rich interface options, and global cellular connectivity support, it offers unparalleled versatility. Featuring Python support for secondary development and integrated DeviceSupervisor™ Agent service, it enables seamless device data acquisition, processing, and cloud integration across various protocols. Additionally, its inclusion of DeviceLive cloud management enhances digitalization efforts for enterprises.

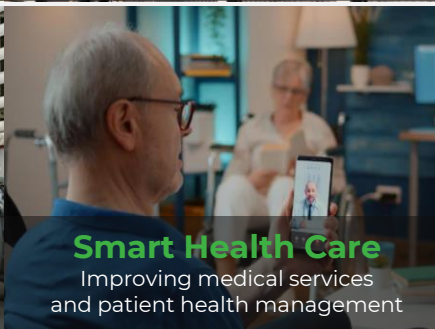
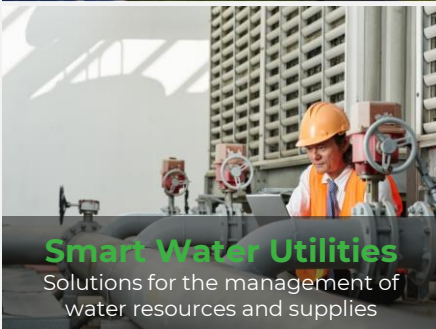

Solution

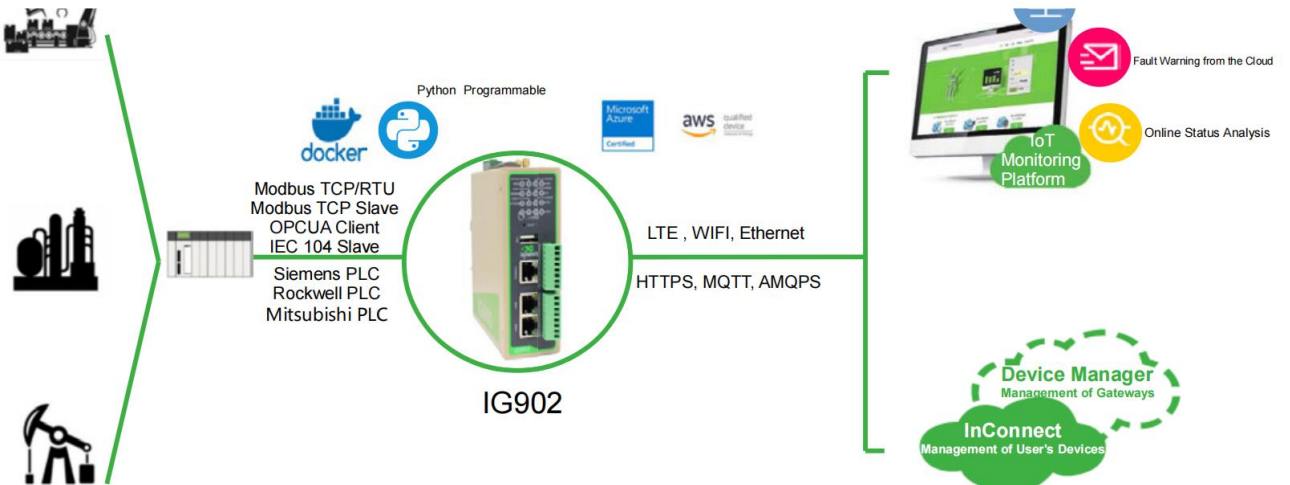

Feature and Advantage

Performance and Platform

- High-performance ARM Cortex-A8 processor, 1GHz
- High capacity 1GB DDR3 RAM and 8GB eMMC Flash
- Gives the cellular gateway powerful edge computing capability, providing computing resources for data optimization, real-time response, agile connection, and intelligent analysis on edge nodes

Rich interfaces

- 2x 10/100/1000 Mbps ethernet interface
- 1x RS-232/RS-485+1x RS-485
- 1x USB2.0
- 1x MicroSD
- 4x DI+3x DO+1x DO/Relay output, optional
- GPS, WIFI and Bluetooth optional

Stable communication

- 4G/Wi-Fi/GbE, etc
- Wired, cellular, Wi-Fi mutual backup, dual SIM failover
- Independent hardware and software watchdog
- Multilevel link detection, communication self-healing

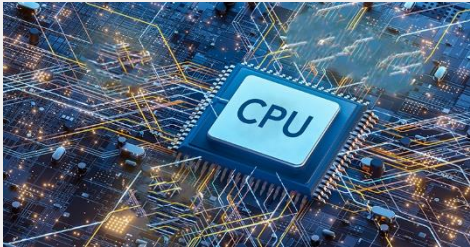

Secondary development platform

- Providing a secondary development platform based on Python/Docker, to achieve customized development
- Offering an integrated programming development environment (SDK) for easy access to system interfaces and resources

DeviceSupervisor™ Agent Service

- "Zero code/Low code" easy to achieve data acquisition on the cloud
- Integrate 80+ mainstream data acquisition protocols
- Support data preprocessing
- Integrated data publishing services, public cloud, private cloud, local SCADA and other seamless access

InHand DeviceLive Cloud Manager

- Supports device remote access
- Supports remote batch management of devices
- Supports DSA remote management
- Supports remote user terminal management



Dimensions (mm)

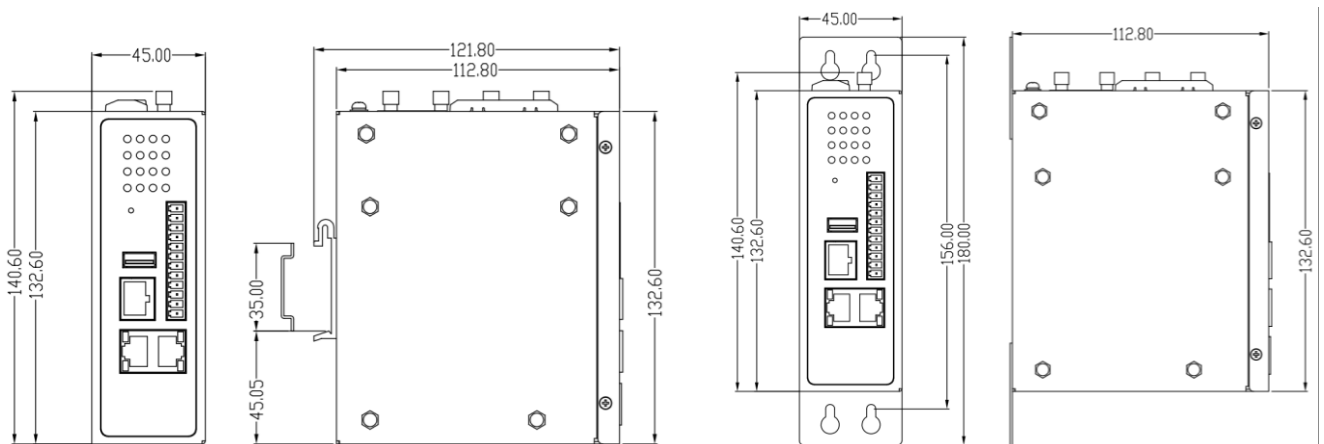

DIN Rail Mounting

Wall Mounting

* Wall Mounting Accessory Number: SSSH160011

Product Specifications

IG902 Hardware Specifications

Item	IG902-B (Basic Version)	IG902-H (High-config Version)	
Hardware Platform			
CPU	ARM Cortex-A8 1GHz	ARM Cortex-A8 1GHz	
RAM	512MB DDR3	1GB DDR3	
FLASH	8GB eMMC	8GB eMMC	
Interfaces			
Ethernet Port	2x 10/100/1000Mbps Ethernet ports, WAN/LAN or 2x LAN		
Industrial Serial Port	1x RS232/RS485 + 1x RS485		
IO	None	4x digital input DI 3x digital/pulse output DO 1x Relay output DO/digital/pulse output DO	
Console Port	1x RS232, RJ45 interface	Wi-Fi (Optional)	Support 2.4G&5G (802.11 ac/a/b/g/n)
USB	1x USB 2.0 port	Reset Button	Pinhole button
SIM Card Slot	1.8V/3V, 2x drawer-type slot	MircoSD Expansion	Up to 32GB
GPS (Optional)	Support GPS and BeiDou		
Mechanical Features			
Installation	DIN-rail, wall mounting	Protection Rating	IP30
Dimensions	141 × 113 × 45mm	Weight	626g
Housing	Metallic structure	Cooling	Fan-less cooling
Power Supply			
Power Input	DC12-48V	Polarity Reverse & Overcurrent Protection	Supported
Power Terminal	Unpluggable industrial terminal connection		
Ambient Temperature and Humidity			
Working Temp.	-25~ 70℃	Ambient Humidity	5~ 95% (non-condensing)
Storage Temp.	-40 ~ 85℃		
Others			
Real-time Clock (Optional)	Embedded real time clock (RTC), powered by super capacitor		
Indicators			
LED	POWER, STATUS, WARN, ERROR, MODEM, SIM1, SIM2, TF (card), PYTHON, USER1, USER2, WIFI, GPS, SIGNAL		
EMC Index			
Electrostatic Discharge	EN61000-4-2, level 3		
Radiated RFI Immunity	EN61000-4-3, level 3		
Electrical Fast Transients/Burst	EN61000-4-4, level 3		
Surge	EN61000-4-5, level 3		
Conducted RFI	EN61000-4-6, level 3		
Power Frequency Magnetic Field	EN61000-4-8, horizontal / vertical 400A/m (>level 3)		
Ring Wave Immunity	EN61000-4-12, level 3		
Physical Features			
Shock	IEC60068-2-27	Vibration	IEC60068-2-6
Free Fall	IEC60068-2-32		
Certification			
CE, FCC, PTCRB, RCM, IC, IMDA, AT&T, MIC&JATE, MSIP, EAC, ANATEL, UKCA			

IG902 Software Specifications

Item	IG902
Network Interconnection	
Network Access	APN, VPDN
Access Authentication	CHAP/PAP/MS-CHAP/MS-CHAPV2
Network Type	LTE, WCDMA(HSPA+) EDGE, GPRS, CDMA
LAN Protocol	ARP, EtherNet
Network Protocols	
IP Application	Ping, Traceroute, DHCP Server/Relay/Client, DNS Relay, DDNS, Telnet, SSH, HTTP, HTTPS, TFTP, FTP, SFTP
IP Routing	Static Routing
Network Security	
Firewalls	Stateful packet inspection (SPI), anti-DoS attack
	Multicast/Ping filter, Access Control List (ACL) NAT, PAT, DMZ, port mapping, virtual server
User Levels	Multi-level user authorization
AAA	Local authentication, Radius, Tacacs+, LDAP
Data Security	IPSec VPN, GRE, L2TP, OPENVPN, CA (may auto apply)
Reliability	
Backup	VRRP, interface backup, dual-SIM backup
Link Detection	Heartbeat packet detection, auto-recovery of disconnection
Embedded Watchdog	Device self-diagnosis, auto-recovery from operation faults
WLAN(Optional)	
Standard	IEEE 802.11 ac/a/b/g/n
Security	Open System, Shared Key, WPA/WPA2 certification, WEP/TKIP/AES encryption
Mode	AP, Client modes
Network Management	
Configuration Method	Local or remote HTTP, HTTPS, Telnet, SSH
Upgrade Method	Local or remote WEB, DeviceLive, TFTP, FTP, SFTP server
Log	Local or remote log export, power-down log saving
Device Management	InHand DeviceLive network management platform, batch management gateway
Network Diagnostics	Ping, Traceroute, Sniffer(network packet capture tool)
Secondary Development Platform	
Open Platform	Secondary development environment: Multi-programming language development platform. (Python, Docker)
Data Acquisition Protocol(*DSA)	
Industrial Protocol	Modbus RTU Master/Slave, Modbus TCP Master/Slave, EtherNet/IP, ISO on TCP, OPC UA Client/Server, Mitsubishi MC 3C/3E/3C OverTCP, Mitsubishi CPU Port, FINSUDP, HostLink, PPI
Electricity Protocol	DLT645-2007, IEC101/104, DNP3.0
Other Protocol	BACnet, CNC
IoT Platform	
IoT Platform	Microsoft Azure, Amazon AWS, and Alibaba Cloud etc.

*DSA: The DeviceSupervisor Agent (DSA), developed by InHand Networks, is a cutting-edge intelligence software designed to operate on Edge Computer products. It enables clients to quickly implement data collection, processing, protocol conversion, and cloud connectivity through a "zero code/low code" approach. If you need the DSA application on the EdgeComputer product, please contact us to obtain the DSA software package.

Interface Definitions

Pin	Name	Definition
1	V+	Positive electrode
2	V-	Negative electrode
3	TXD/A	Serial RS232 send/Serial RS485 +
4	RXD/B	Serial RS232 receive/Serial RS485 -
5	GND	Serial RS232 signal ground
6	A	Serial RS485 +
7	B	Serial RS485 -

7 PIN Power/Serial Port Terminal

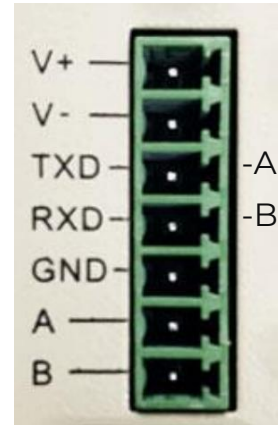

Power/Serial Port Terminal

Pin	Name	Definition	Description
1	PCOM	Dry contact access point	Dry contact status "1": closed Dry contact status "0": disconnected Wet contact status "1": +10~+30V/-30~-10VDC Wet contact status "0": 0~+3V/-3~0V Isolation 3000VDC Pulse signal counter supported, supports up to 100Hz pulse signal Isolation 3000VDC
2	DGND	Dry contact ground point	
3	DICOM	Input common port	
4	DI0	Digital/pulse input port 0	
5	DI1	Digital/pulse input port 1	
6	DI2	Digital/pulse input port 2	
7	DI3	Digital/pulse input port 3	
8	NC	None	
9	DO0	Digital/pulse output port 0	
10	DGND	Ground	
11	DO1	Digital/pulse output port 1	
12	DGND	Ground	
13	DO2	Digital/pulse output port 2	
14	DGND	Ground	
15	DO3/Relay Output	DO3: Digital/pulse output port 3 Relay Output: 1 A 250 VAC / 30VDC	
16	DGND	Ground	

I/O Port Terminal Definition

Relay output

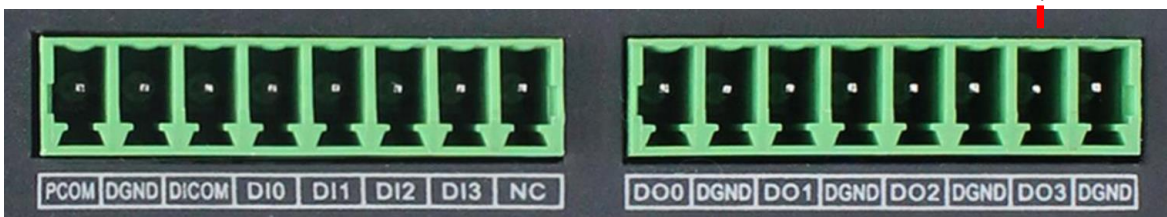

I/O Port Terminal

Ordering Guide

Model code: IG902-<B/H>-<WMNN>-<IO/RIO/NA>-<DW/NA>-<G/NA>							
Model	Version	<WMNN>: Cellular Type & Frequency Band	Serial Port	IO	Wi-Fi	GPS	
IG902-B-LQA8	Basic	China LTE CAT4 LTE-FDD Band 1/3/5/8	RS232 x1, RS485 x1	NO	NO	NO	
IG902-B-LQA8-DW-G	Basic	LTE-TDD Band 34/38/39/40/41	RS232 x1, RS485 x1	NO	YES	YES	
IG902-H-LQA8-IO	High-config	TD-SCDMA Band 34/39 WCDMA Band 1/8	RS232 x1, RS485 x1	4x DI+4x DO	NO	NO	
IG902-H-LQA8-IO-DW-G	High-config	CDMA BCO GSM 900/1800 MHz	RS232 x1, RS485 x1	4x DI+4x DO	YES	YES	
IG902-B-FQ58	Basic		RS232 x1, RS485 x1	NO	NO	NO	
IG902-B-FQ58-DW-G	Basic	Europe & APAC LTE CAT4 LTE-FDD Band 1/2/3/5/7/8/20	RS232 x1, RS485 x1	NO	YES	YES	
IG902-H-FQ58-IO	High-config	LTE-TDD Band 38/40/41 UMTS(DC-HSPA+)	RS232 x1, RS485 x1	4x DI+4x DO	NO	NO	
IG902-H-FQ58-IO-DW-G	High-config	Band1/5/8 GSM Band 3/8	RS232 x1, RS485 x1	4x DI+4x DO	YES	YES	
IG902-H-FQ58-D485-RIO-DW-G	High-config		RS485 x2	4x DI+3x DO+ 1x Relay output	YES	YES	
IG902-B-FS39	Basic		RS232 x1, RS485 x1	NO	NO	NO	
IG902-B-FS39-DW-G	Basic	North America LTE CAT 6 LTE-FDD Band 2/4/5/13/17	RS232 x1, RS485 x1	NO	YES	YES	
IG902-H-FS39-IO	High-config	UMTS(DC-HSPA+) Band2/5	RS232 x1, RS485 x1	4x DI+4x DO	NO	NO	
IG902-H-FS39-IO-DW-G	High-config		RS232 x1, RS485 x1	4x DI+4x DO	YES	YES	
IG902-B-FQ78	Basic	Australia & South America LTE CAT4 LTE-FDD Band 1/2/3/4/5/7/8/28	RS232 x1, RS485 x1	NO	NO	NO	
IG902-B-FQ78-DW-G	Basic	LTE-TDD B40	RS232 x1, RS485 x1	NO	YES	YES	
IG902-H-FQ78-IO	High-config	UMTS(DC-HSPA+) Band1/2/5/8	RS232 x1, RS485 x1	4x DI+4x DO	NO	NO	
IG902-H-FQ78-IO-DW-G	High-config	EDGE/GPRS/GSM 850/900/1800/1900MHz	RS232 x1, RS485 x1	4x DI+4x DO	YES	YES	
IG902-B-FQ88	Basic		RS232 x1, RS485 x1	NO	NO	NO	
IG902-B-FQ88-DW-G	Basic	Japan LTE CAT4 LTE FDD: Band 1/3/8/18/19/26	RS232 x1, RS485 x1	NO	YES	YES	
IG902-H-FQ88-IO	High-config	LTE TDD: Band41 WCDMA: Band 1/6/8/19	RS232 x1, RS485 x1	4x DI+4x DO	NO	NO	
IG902-H-FQ88-IO-DW-G	High-config		RS232 x1, RS485 x1	4x DI+4x DO	YES	YES	
IG902-B-FQ98	Basic		RS232 x1, RS485 x1	NO	NO	NO	
IG902-B-FQ98-DW-G	Basic	South Korea LTE CAT4 LTE FDD Band 1/3/5/7/8/20 LTE TDD Band 38/40/41	RS232 x1, RS485 x1	NO	YES	YES	
IG902-H-FQ98-IO	High-config	WCDMA Band 1/5/8 EDGE/GSM Band 3/8	RS232 x1, RS485 x1	4x DI+4x DO	NO	NO	
IG902-H-FQ98-IO-DW-G	High-config		RS232 x1, RS485 x1	4x DI+4x DO	YES	YES	
IG902-B-EN00	Basic		RS232 x1, RS485 x1	NO	NO	NO	
IG902-B-EN00-DW-G	Basic	Global No 3G/4G communication module	RS232 x1, RS485 x1	NO	YES	YES	
IG902-H-EN00-IO	High-config		RS232 x1, RS485 x1	4x DI+4x DO	NO	NO	
IG902-H-EN00-IO-DW-G	High-config		RS232 x1, RS485 x1	4x DI+4x DO	YES	YES	

About Us

InHand Networks is a leading IoT solutions provider founded in 2001, dedicated to driving digital transformation across industries and empowering customers to unlock their full potential and achieve accelerated growth.

We specialize in delivering industrial-grade connectivity solutions for diverse sectors, such as enterprise networks, industrial and building IoT, digital energy, smart commerce, and mobility. Our comprehensive product portfolio and services cater to various applications worldwide, including smart manufacturing, smart grid, intelligent transportation, smart retail, etc. With a global footprint spanning over 60 countries, we serve customers in China, the United States, France, Germany, the United Kingdom, Italy, and beyond.



3650 Concorde Pkwy, Suite 200
Chantilly, VA 20151, USA
T: +1 (703) 348-2988
E: info@inhand.com
www.inhand.com