

Stay Connected Anywhere

CR202-Pro Portable 4G Router

- 4G
- Wi-Fi
- Built-in battery
- Cloud-Managed



The CR202-Pro is a versatile cellular router that integrates various network access technologies, including 4G, Wi-Fi, and wired connections. This integration empowers the router with powerful network access capabilities, providing a high-speed data pathway in any scenario. Adding to its flexibility, the CR202-Pro is equipped with a built-in 5000mAh lithium battery, ensuring consistent network connectivity wherever you go. This portable feature enables users to relish uninterrupted and high-speed network access at any time and from anywhere.

Combined with the InHand Device Manager cloud management platform, the CR202-Pro offers customers straightforward remote management services to empower your core business.

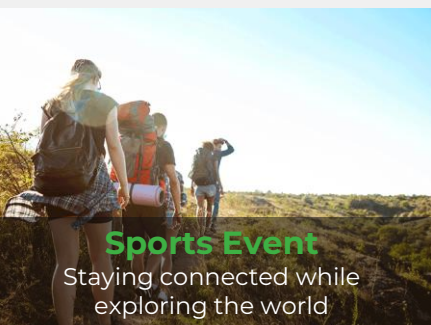
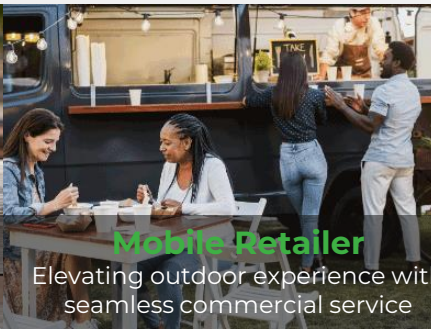
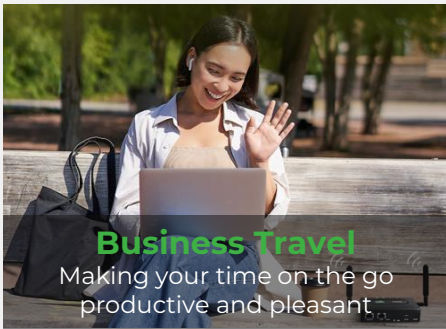
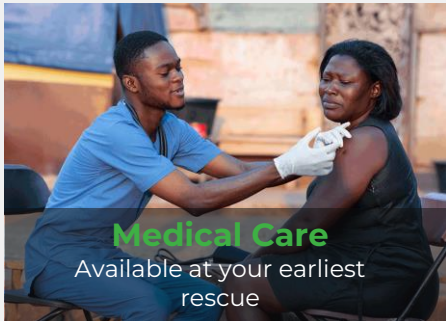

Features and Advantages

Convenient Network Access

The CR202-Pro boasts versatile network access capabilities, encompassing cellular, wired, and Wi-Fi connectivity, making it suitable for diverse network scenarios. This ensures the provision of convenient and efficient network access services.



“Always-on” connectivity

The CR202-Pro is equipped with advanced features such as link backup, link detection, dual SIM switching, optional eSIM, and more, ensuring a reliable and robust connection. These features are designed to guarantee network stability and reliability for your connectivity needs.



Compact and Portable

The CR202-Pro showcases a compact, detachable design with a built-in powerful battery. Its portable form factor enables it to deliver network access services anytime and anywhere, catering to both fixed and mobile scenarios with ease.



Device Manager-Cloud management

The CR202-Pro seamlessly integrates with the Device Manager, enabling real-time management of tens of thousands of distributed devices through a unified cloud platform. Monitor on-site device status anytime, anywhere, streamlining management for enhanced efficiency and cost-effectiveness!

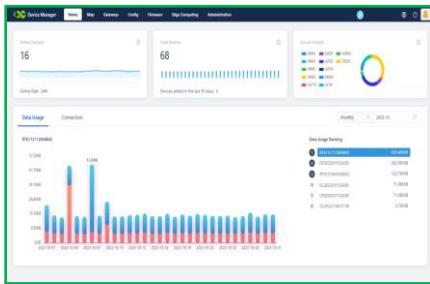

Total Control

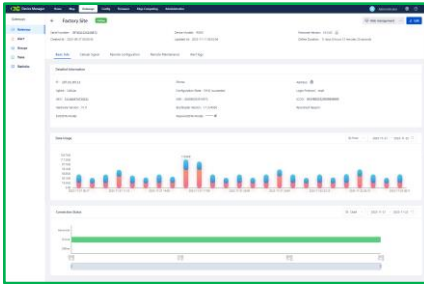

Device Details

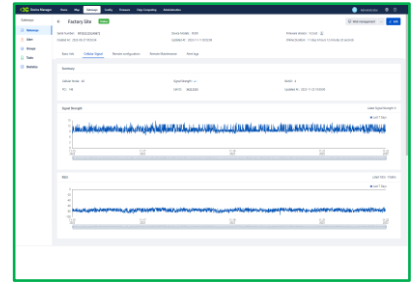

Cellular Quality

Dimensions (mm)

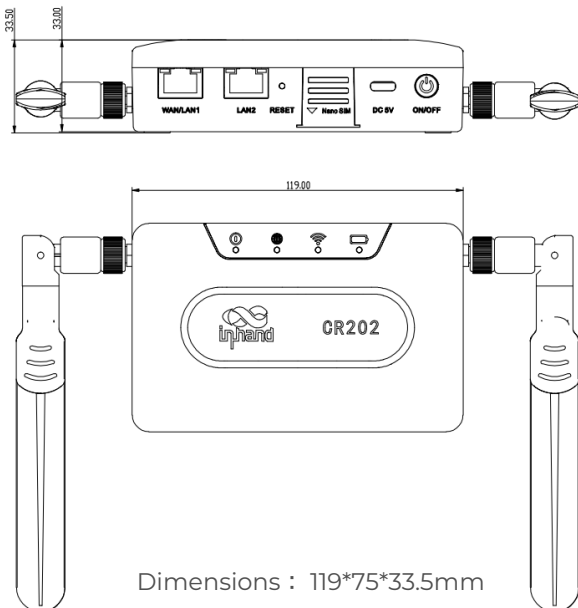

Dimensions : 119*75*33.5mm

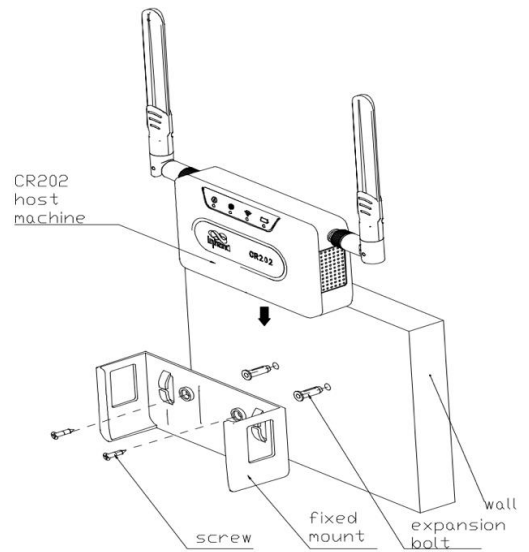

Specifications

CR202-Pro Hardware	
Hardware Platform	
Data Throughput	100Mbps
Recommended No. of Users	30
Interface Description	
Cellular	4G LTE CAT6 300 Mbps (DL) /50 Mbps (UL)
Ethernet Port	2 x 10/100Mbps WAN/LAN switchable Dual-LAN
SIM	1 x SIM, Nano 4FF SIM slot 1 x eSIM
Reset	Reset button
ON/OFF	ON/OFF button
Antenna Interface	2 * external 4G cellular antennas and 2 * internal 4G cellular antennas
Lights	Power/ Cellular/ Wi-Fi/ Battery
Wi-Fi	
Radio Frequency	Single band 2.4GHz
Max Transmission Bandwidth	300Mbps
Transfer Protocol	802.11 b/g/n
Operating Mode	AP/STA mode
Power Supply	
Power	TYPE-C
Power Consumption	5V/2A
Battery	
Battery Capacity	5000mAh
Lasts up	12 hours
Mechanical Features	
Installation	Panel Mounting, Wall Mounting
Dimensions	119*75*33mm
Weight	265g
Housing	ABS+PC
Cooling	Fanless
Environment	
Working Temperature	-10° C to 50° C (14° F to 122° F)
Storage Temperature	-20° C to 60° C (-4° F to 140° F)
Protection Level	IP30
Certification	
Certificates	FCC, PTCRB, UN38.3, IC, Verizon, AT&T, T-Mobile
Warranty	3 years (Battery: 1 year)

Note: The functions marked with * are not available yet.

CR202-Pro Software	
Device Management	
Device Manager	Centralized management platform Simple and intuitive dashboard User-friendly management Multidimensional visual management
Network Connection	
Network Access	APN
Access Authentication	CHAP/PAP
Network Standard	GSM/EDGE, WCDMA, TDD LTE/FDD LTE The specific frequency bands, please refer to the ordering information table.
LAN Protocol	ARP
WAN Protocol	Static IP, PPPoE, DHCP
Network Protocol	
IP Application	Ping, Trace, DHCP Server, DHCP relay, DHCP Client, DNS relay, DDNS, Telnet, IP Passthrough
Routing	Static routing
NAT	Supports NAT
Security	
Network Security	Stateful Packet Inspection (SPI), DoS attack defense; Multicast filter/Ping probe packet, Access Control List (ACL); Content URL filter, port mapping, virtual IP mapping, IP-MAC binding
Data Security	Supports IPSEC VPN, OPENVPN Client & Server, WireGuard, ZeroTier Supports CA digital certificate
Reliability	
Link Backup	Supports link backup
Link Detection	Sends heartbeat packets to detect, auto redials when disconnected
Dual SIM Failover	Supports dual SIM failover
Embedded Watchdog	Device runs self-detection, auto recovers from malfunctions
Network Management	
QoS Management	Bandwidth limit, IP speed limit
Configuration	Telnet, web, SSH
Update	Web, DeviceManager
Log	Local system log, remote log, and serial export of log. Power down saving of important logs.
SMS Functions	Status query, restart
SNMP	Support SNMP v1/v2c/v3 and SNMP Trap
Dial-on-demand	Dial-on-demand, data / SMS activation
Network Management	Supports InHand Device Manager, batch management Add the user experience plan to access The InHand Networks cloud platform to enjoy efficient and convenient services
Traffic Management	Supports data traffic threshold, traffic statistics and traffic alarm
Alarm	System restart alarm, LAN port online/offline alarm, data traffic alarm, SIM card failure alarm, etc.
Maintenance Tools	Ping, route tracking, network speed test, TCPDUMP
Status Query	System status, modem status, network connection status, and routing status

Ordering Guide

Model code: CR202-<WMNN>-WLAN-B-Pro

Model	<WMNN>: Cellular Types & Modules	WLAN: Wi-Fi	B:Battery
CR202-NAC6-WLAN-B-Pro	North America LTE-FDD: B2/4/5/7/12/13/14/25/26/29/30/66/71 LTE-TDD: B41/48	WLAN: Wi-Fi	B: Battery

Note: Users are asked to join InHand User Experience Plan at first time login. If user agreed to join, the router will connect to InHand DeviceManager portal. If users want to disable it, please go to Services->User Experience Plan to change the setting.

InHand Cloud-Managed Networking Solution

Our solution encompasses cloud-managed 4G cellular routers, 5G FWA/ODU cellular routers, Wi-Fi access points, switches, and the InCloud Manager SaaS. By integrating top-tier IT management, IoT, 5G, and other technologies, we provide fast, secure, and user-friendly network solutions globally, enabling businesses to unlock boundless growth opportunities.



InCloud Manager

- Centralized management
- Efficient zero touch deployment
- Simplified network configuration
- Multi-dimensional security
- Multiple intelligent strategies



5G FWA02

- High-speed 5G, DL 4.76Gbps, UL 1.25Gbps
- 802.11ax, maximum speed 3600Mbps
- 2.5G ETH, WAN/LAN
- Link backup, cellular failover, load balancing
- Wall and desktop installation



5G Outdoor Unit

- High-speed 5G, DL 4.76Gbps, UL 1.25Gbps
- 2Gbps throughput
- 2.5G ETH, WAN/LAN, PoE
- IP67, -30~70° C, GPS
- Wall & pole mounting with adjustable angles

About Us

InHand Networks is a leading IoT solutions provider founded in 2001, dedicated to driving digital transformation across industries and empowering customers to unlock their full potential and achieve accelerated growth.

We specialize in delivering industrial-grade connectivity solutions for diverse sectors, such as enterprise networks, industrial and building IoT, digital energy, smart commerce, and mobility. Our comprehensive product portfolio and services cater to various applications worldwide, including smart manufacturing, smart grid, intelligent transportation, smart retail, etc. With a global footprint spanning over 60 countries, we serve customers in China, the United States, France, Germany, the United Kingdom, Italy, and beyond.



3650 Concorde Pkwy, Suite 200,
Chantilly, VA 20151, USA
T: +1 (703) 348-2988
E: info@inhand.com
www.inhand.com